



EBERHARD™
[ENGINEERED : ACCESS : SOLUTIONS]



LOAD  LOCK
SECURED BY **EBERHARD™**

INNOVATIVE LOCKING + STORAGE SOLUTIONS
LOCK YOUR TRUCK. LOCK YOUR GEAR.

CUSTOM SECURED SOLUTIONS

Eberhard has been collaborating with our customers to design custom secured access solutions in the vehicle accessories industry for a combined 235 years. Because our hardware is often an end-user's first touchpoint with your product, we work side-by-side with our customers to engineer seamless solutions. This process creates an end-user experience that reinforces the quality of your brand while maintaining the integrity of security parameters, haptics, and audio and visual cues.



Eberhard relentlessly focuses on our key markets to invent valued solutions, while obsessing on creating an exceptional business experience for our partners. We drive operational excellence into our processes and capabilities while continuously creating growth for our employees, partners, and shareholders.

Custom Secured Solutions	2
Power Adaptable Handles.....	4
Power Adaptable Handles : Standard	5
Power Adaptable Handles : Custom-Designed	6
Electronics : Power Lock Kit	7
Rotary Latches.....	8
Power Adaptable Rotary Latches.....	10
Electronics : Power Pop Kit	11
Tonneau Hinges : Custom-Designed.....	13
Hardware + Accessories.....	14

POWER ADAPTABLE HANDLES

Load N Lock has set the standard for truck cap and tonneau handles. Our solutions are engineered to fit our customers' industrial design. Standard locking bolts seamlessly integrate with our patented power adaptable module and each design incorporates a key override.



Standard Features:

- 1 1/8" mounting hole design, custom sizes available
- Labyrinth bushing with o-ring between key cylinder, handle bushing, and handle
- Heavy duty .340" diameter internal stainless steel deadbolt design
- Stainless steel key cylinder dust cover
- Stainless steel springs
- EPDM UV stable gasket with 3M adhesive
- Pair of over-molded keys

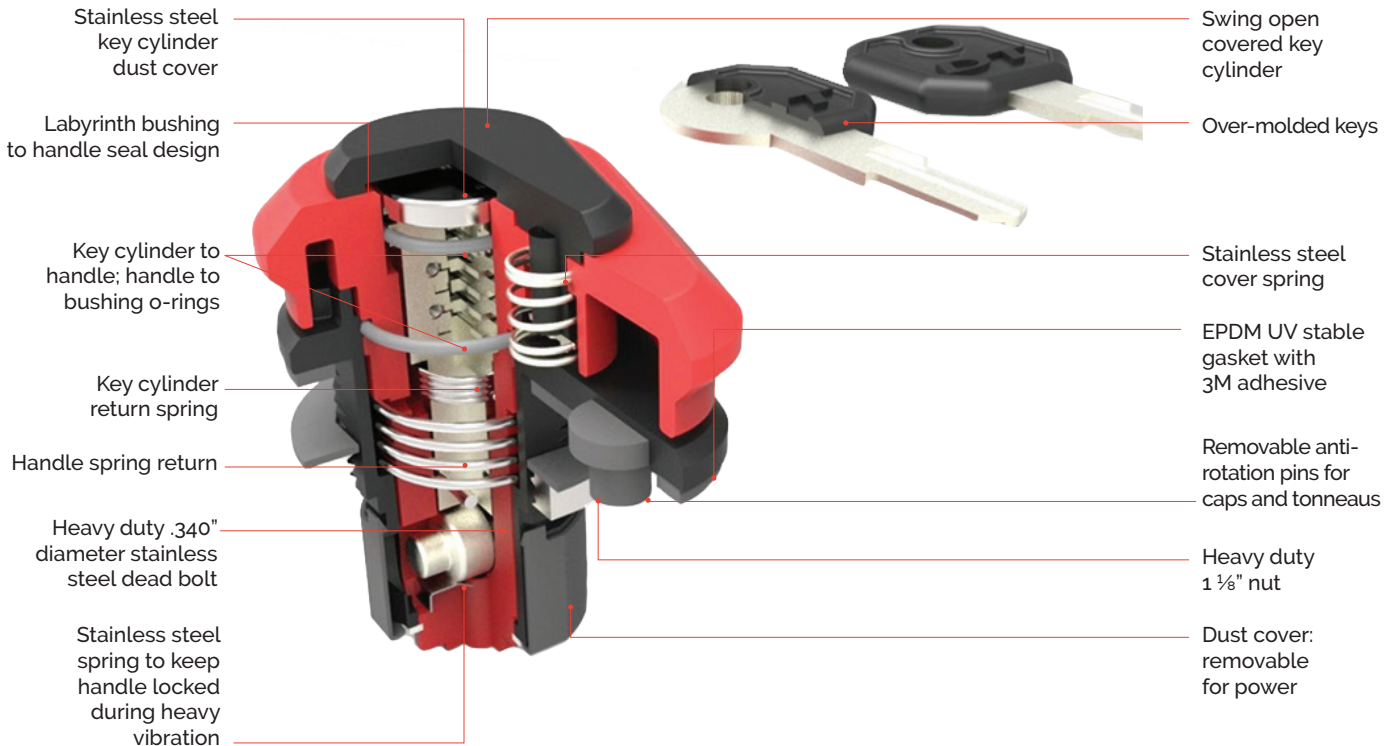

POWER ADAPTABLE HANDLES : STANDARD

Our mechanical handles are designed and built to be power adaptable. The module can be installed by the OEM or as an aftermarket addition.

FEATURES	PART N°
	<ul style="list-style-type: none">• Low profile teardrop design provides easy finger grip• Key plug hidden under rotating lock cover <p>LNL-70-00585</p>
	<ul style="list-style-type: none">• Full size T-shape allows full hand grip• Key plug is hidden under a full handle flip up lock cover <p>LNL-70-00775</p>
	<ul style="list-style-type: none">• Lever design offers positive hand wrap• Stainless steel scalped key plug with dust shutter <p>LNL-70-01760</p>
	<ul style="list-style-type: none">• Simple rotating button cover design• Key plug protected under rotating lock cover• This product is not power adaptable <p>LNL-70-00181</p>

POWER ADAPTABLE HANDLES : CUSTOM-DESIGNED

We understand that not all challenges are solved with standard products. With a combined 235 years of access and security hardware engineering knowledge, we have the expertise and experience to custom design a power adaptable handle to fit your unique application.

FEATURES



- T-Handle for truck cap glass applications
- Stainless steel scalped key plug with dust shutter
- Allows for double rod connections



- Four finger pocket handle for lift up and out applications
- Stainless steel scalped key plug with dust shutter
- Allows for double rod connections



- Contractor/utility truck flush mount t-handle
- Fits standard door pocket
- Stainless steel scalped key plug with dust shutter
- Allows for double rod connections
- Black or bright finish available

A power module can be attached to any of our handles by sliding it on and snapping an e-clip into place. Installed at the factory, dealership, or by the end customer, this product easily ties into the vehicle's existing power lock system. Installation time is under 28 minutes.



PATENTED KEYLESS POWER ADAPTABLE REMOTE ENTRY KIT - LNL-72-00772*

* Many other kits for caps and tonneaus available.















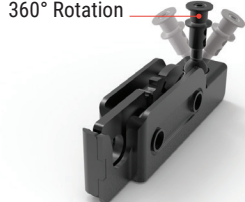



Standard Features:

- Installation in under 28 minutes
- Integration with vehicle FOB
- Works with all power adaptable handles
- No special tools required for installation

ROTARY LATCHES

Our joystick rotary latch offers multi-directional actuation and is a simple solution to many applications where a left hand (LH) or right hand (RH) part would be integrated. This flexibility reduces your bill of materials and SKU count. See our full range of solutions below.

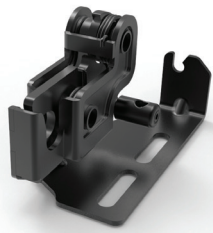
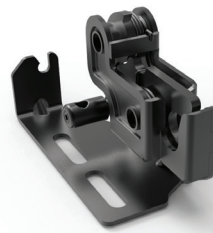
 <p>R6 LH</p>	 <p>R6 RH</p>	 <p>R9 LH</p>	 <p>R9 RH</p>
 <p>R1 LH</p>	 <p>360° Rotation</p>		 <p>Geomet under black E-coat finish</p> <p>Case-hardened internal components for increased life</p> <p>1/4 - 20 through threaded axles</p> <p>Bottom pull design creates better cable and rod angles</p>
 <p>R3 LH</p>	 <p>R3 RH</p>	 <p>R4 LH</p>	 <p>R4 RH</p>
 <p>R5 LH</p>	 <p>R5 RH</p>	 <p>R7 LH</p>	 <p>R7 RH</p>
 <p>R8 LH</p>	 <p>R8 RH</p>	 <p>R10 LH</p>	 <p>R10 RH</p>

Eberhard offers the Load N Lock product line of rotary latches designed and tested for applications in truck caps, tonneaus, and automotive storage solutions – including roof-top cargo boxes and sport racks. The simple, robust design allows for the smoothest release and feel in the industry. This is ideal for applications where the end-user is releasing the mechanism mechanically or electronically. The patented design features intuitive cable connections, keeping the cables or rods in line with the actuator and close to the panel surface, which reduces the activation angle and trigger forces.

Standard Features:

- Single stage rotary non-FMVSS compliant
- Average actuation force: 2.5 lbs
- Mounting holes: 1/4 - 20 threaded
- Material + Finish: Steel; Black E-coat

PRODUCT FAMILY	APPLICATION GUIDE	AVG. CLOSING FORCE	TRIGGER STYLE	ACTUATION TYPE	MOUNTING STYLE	PART NUMBER	
R6	LITE PRELOAD	4 LBS	BOTTOM EYELET + SET SCREW	LH	THRU-BODY	LNL-77-01751	
				RH	THRU-BODY	LNL-77-01750	
R9	LITE PRELOAD	4 LBS		LH	MOUNTING FOOT	LNL-77-01789	
				RH	MOUNTING FOOT	LNL-77-01787	
R1	MEDIUM PRELOAD	10 LBS		JOYSTICK	MULTI, 360°	THRU-BODY	LNL-77-00046
R3	MEDIUM PRELOAD	10 LBS		BOTTOM EYELET + SET SCREW	LH	THRU-BODY	LNL-77-00289
			RH		THRU-BODY	LNL-77-00287	
R4	MEDIUM PRELOAD	10 LBS	LH		THRU-BODY	LNL-77-00751	
			RH		THRU-BODY	LNL-77-00750	
R5	HIGHER PRELOAD	20 LBS	LH		THRU-BODY	LNL-77-00791	
			RH		THRU-BODY	LNL-77-00790	
R7	HIGHER PRELOAD	20 LBS	LH		MOUNTING FOOT	LNL-77-01941	
			RH		MOUNTING FOOT	LNL-77-01940	
R8	HIGHER PRELOAD	20 LBS	LH		MOUNTING FOOT W/ CABLE GUIDE THRU-HOLE	LNL-77-01945	
			RH			LNL-77-01944	
R10	HIGHER PRELOAD	20 LBS	LH	MOUNTING FOOT W/ CABLE GUIDE NOTCH	LNL-77-01956		
			RH		LNL-77-01955		

POWER ADAPTABLE ROTARY LATCHES

Load N Lock's proprietary rotary latch design is easily power adaptable. The actuator and its supplied mounting hardware attach to the rotary creating a seamless, compact solution that matches the release force of the rotary selected.



Standard Features:

- Actuator, 8-13vdc voltage range
- Spaded terminal connection
- Steel; Geomet with black E-coat finish mounting bracket
- Custom mounts available





Standard Features:

- Aftermarket Power Pop Kit makes a tonneau work like the trunk of your vehicle
- Separate FOB
- Installation in approximately 90 minutes
- All parts needed for installation and cab tonneau pop included

POWER POP KIT - LNL-72-02000

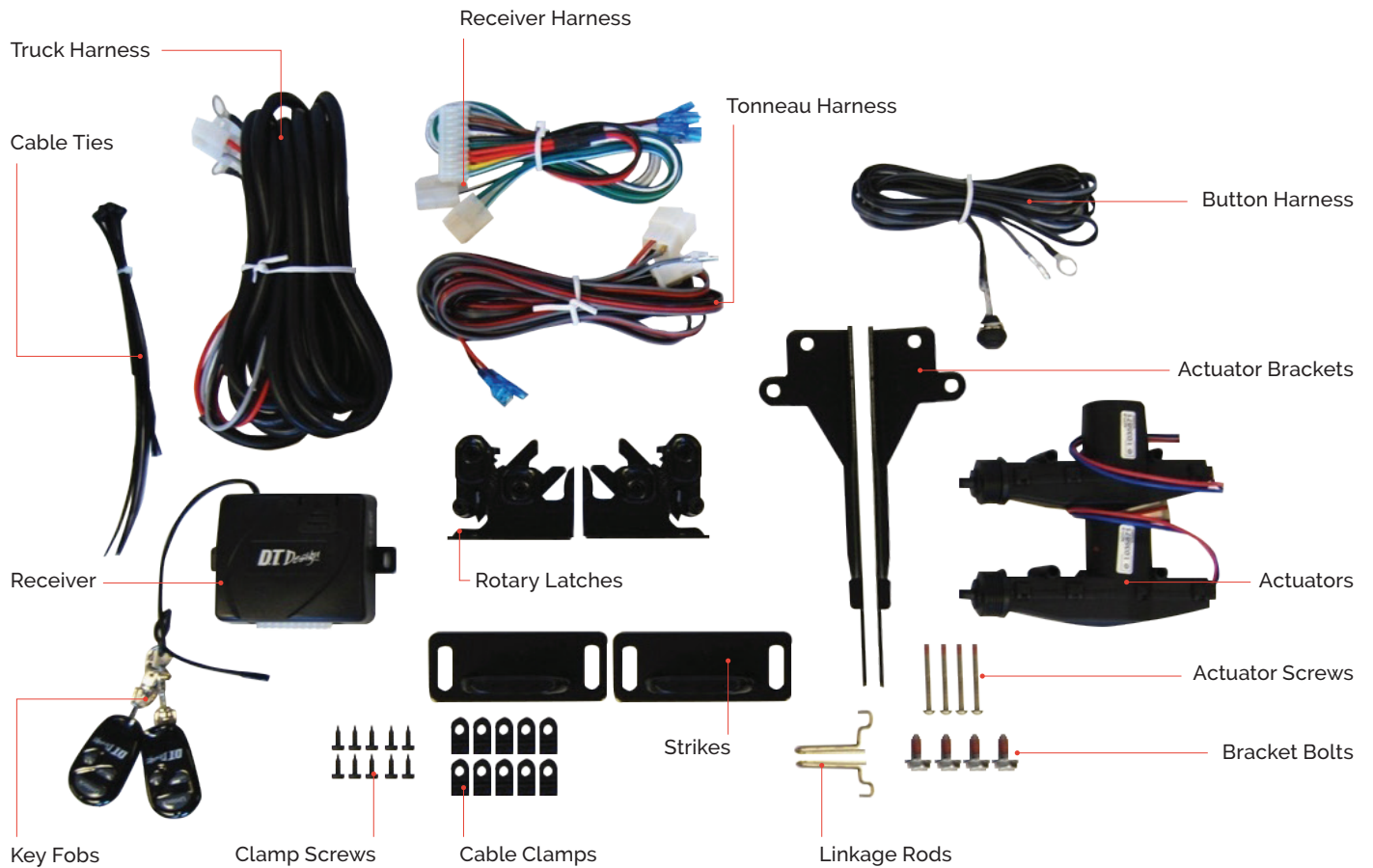



FX4
OFF ROAD

PLATINUM

F150

KOMATSU

160
LC

KOMATSU

KOMATSU

Each hinge is custom-engineered using our patented 4-bar linkage system to match our customers' application. This includes the required lifting force, lifting height, and range of motion. Use with our rail systems or as standalone components. Contact us to discuss options and request information.



Standard Features:

- Patented geometry results in nearly 4" of vertical movement; creates greater open area for easier access to your cargo
- Stainless steel rivets combined with Teflon-coated bushings result in smooth, corrosion free movement
- Our patented quick release hinge design requires no tools for removal
- Geomet under black E-coat finish withstands years of harsh environmental punishment

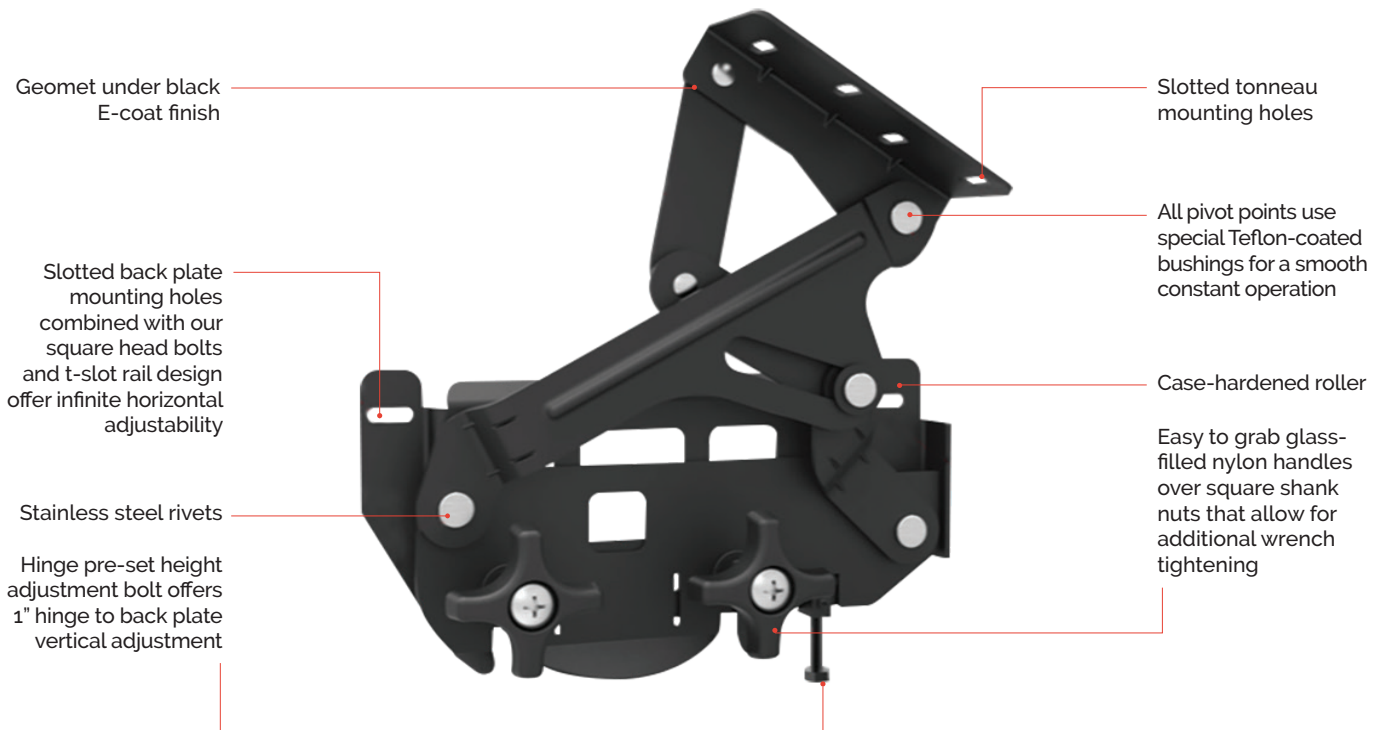

HARDWARE + ACCESSORIES

Our hardware and accessories are designed to work with our full Load N Lock product line to create a complete package for your application.

Standard Features:

- Geomet under black E-coat finish
- Proven superior corrosion resistance

PART N°



Lower Striker Bracket

LNL-77-00459



Gas Cylinder Mount

LNL-77-00084



90° Striker Mounting Bracket

LNL-77-00088



Adjustable Striker

LNL-77-00627



U-Hook Striker

LNL-77-00087



Emergency Release

LNL-70-00681



Black Pull Strap

LNL-76-00558

- 1.5" x 12" or 1.5" x 18"
- Triple stitched high quality polypropylene
- Heavy duty brass grommet





EBERHARD™
[ENGINEERED : ACCESS : SOLUTIONS]

LOAD N LOCK PRODUCT LINE  SECURED BY **EBERHARD™**

21944 Drake Road | Strongsville, OH 44149-9712 | 440-238-9720 | eberhard.com | sales@eberhard.com | 9.21